

### Complete Bar Buddy™ Sectionizer Model

Complete Sectionizer unit comes with Blade Cup of your choice, and corresponding Plunger.

| Units Per Master Ctn. | Weight Per Master Ctn. | Suggested List Price |
|-----------------------|------------------------|----------------------|
| 1                     | 5                      | \$129.00             |

| Complete Sectionizer Bar Model | Blade Cup Style | Description  |
|--------------------------------|-----------------|--|
| B-201                          | 4 Wedge         | 4 evenly spaced and cut wedges.                            |
| B-202                          | 6 Wedge         | 6 evenly spaced and cut wedges.                            |
| B-203                          | 6 Slice         | 6 Slices 5/16" thick (must use Plunger S-10).              |
| B-204                          | 8 Wedge         | 8 evenly spaced and cut wedges.                            |
| B-205                          | 3-in-1          | 2 halves scored in 3 wedges each (for school foodservice). |
| B-207                          | Single          | Cuts fruit & vegetables in half.                           |
| B-210                          | 10 Wedge        | 10 evenly spaced and cut wedges.                           |

### Basic Bar Buddy™ Sectionizer Model

B-200 – Basic Bar Buddy Sectionizer Unit  
No Plunger and No Blade Cup

| Units Per Master Ctn. | Weight Per Master Ctn. | Suggested List Price |
|-----------------------|------------------------|----------------------|
| 1                     | 5                      | \$103.00             |

### Apple Sectionizer Model

B-206 – Apple Model  
6 evenly spaced and cut wedges

| Units Per Master Ctn. | Weight Per Master Ctn. | Suggested List Price |
|-----------------------|------------------------|----------------------|
| 1                     | 5                      | \$149.00             |

### Tomato Sectionizer Model

B-209 – Serrated Blades - Tomato Model  
7 evenly spaced and sliced - recommended for tomatoes, kiwis, mushrooms, strawberries and hardboiled eggs.

| Units Per Master Ctn. | Weight Per Master Ctn. | Suggested List Price |
|-----------------------|------------------------|----------------------|
| 1                     | 5                      | \$144.00             |

### Individual Parts – Optional

8 wedge, 6 wedge, 4 wedge, 3-in-1 and single wedge cups are interchangeable and use the same plunger. A wedger may be changed to a slicer or slicer to wedger by replacing cup, plunger and neoprene cup cover.  
S-32 Apple Blade Cup can only be used with S-33 Apple Plunger.

| Part Number | Parts Description  | Cost    |
|-------------|--|---------|
| B-1         | Container - 2.7 Quart                                      | \$19.00 |
| B-2         | Lid - 2.7 Quart  | 5.00    |
| B-3         | 2.7 Quart Assembly - Container & Lid (B-1 & B-2)           | 22.00   |
| B-4         | Cup Holder   | 41.00   |
| B-5         | Plunger Assembly   | 68.00   |
| S-3B        | Blade Cup w/cover (6 wedge) (fits S-9)                     | 52.00   |
| S-4B        | Blade Cup w/cover (6 slice) (fits S-10)                    | 66.00   |
| S-5B        | Blade Cup w/cover (4 wedge) (fits S-9)                     | 49.00   |
| S-6         | Wedger Cup cover (sold w/S-3, S-5, S-29, S-30, S-32, S-35) | 13.00   |
| S-7         | Slicer Cup cover (sold w/S-4)                              | 13.00   |
| S-9         | Plunger Wedger (fits parts S-3, S-5, S-29, S-30, S-35)     | 26.00   |
| S-10        | Plunger Slicer fits part S-4 only                          | 26.00   |
| S-11C       | Brass Knob   | 3.00    |
| S-11D       | Brass Stud   | 3.00    |
| S-15        | 7 Slice serrated Blade Cup w/cover (fits S-16)             | 80.00   |
| S-16        | Plunger Tomato Slicer (fits S-15)                          | 30.00   |
| S-17        | Tomato Set (S-15 & S-16)                                   | 103.00  |
| S-19        | Wedger Cup Cover   | 13.00   |
| S-20        | Blade Cup w/cover  | 56.00   |
| S-21        | Plunger  | 27.00   |
| S-22        | 10 Wedge Set   | 77.00   |
| S-29B       | Blade Cup w/cover (8 wedge) (fits S-9)                     | 54.00   |
| S-30B       | Blade Cup w/cover (3-in-1) (fits S-9)                      | 60.00   |
| S-32B       | Apple Corer Cup (fits S-33)                                | 90.00   |
| S-33        | Apple Plunger (fits S-32)                                  | 32.00   |
| S-34        | Apple Corer Set (S-32 & S-33)                              | 108.00  |
| S-35B       | Single Blade Cup w/cover (fits S-9)                        | 46.00   |









### Additional Containers & Lids Available



B-3. 2.7 Quart Assembly – Container & Lid (B-1 & B-2)

Overall Dimensions .....7" high, 7" wide  
Shipping Weight .....1½ pounds

### Blade Cup Styles

|   |                |              |
|---|----------------|--------------|
|    | PLUNGER<br>CUP | S-9<br>S-5   |
| 4 Wedge   |                |              |
|    | PLUNGER<br>CUP | S-9<br>S-3   |
| 6 Wedge   |                |              |
|    | PLUNGER<br>CUP | S-10<br>S-4  |
| 6 Slice   |                |              |
|    | PLUNGER<br>CUP | S-9<br>S-29  |
| 8 Wedge   |                |              |
|    | PLUNGER<br>CUP | S-9<br>S-30  |
| 3-in-1  |                |              |
|   | PLUNGER<br>CUP | S-33<br>S-32 |
| Apple Model   |                |              |
|  | PLUNGER<br>CUP | S-9<br>S-35  |
| Single  |                |              |
|  | PLUNGER<br>CUP | S-16<br>S-15 |
| Tomato Model  |                |              |
|  | PLUNGER<br>CUP | S-21<br>S-20 |
| 10 Wedge  |                |              |

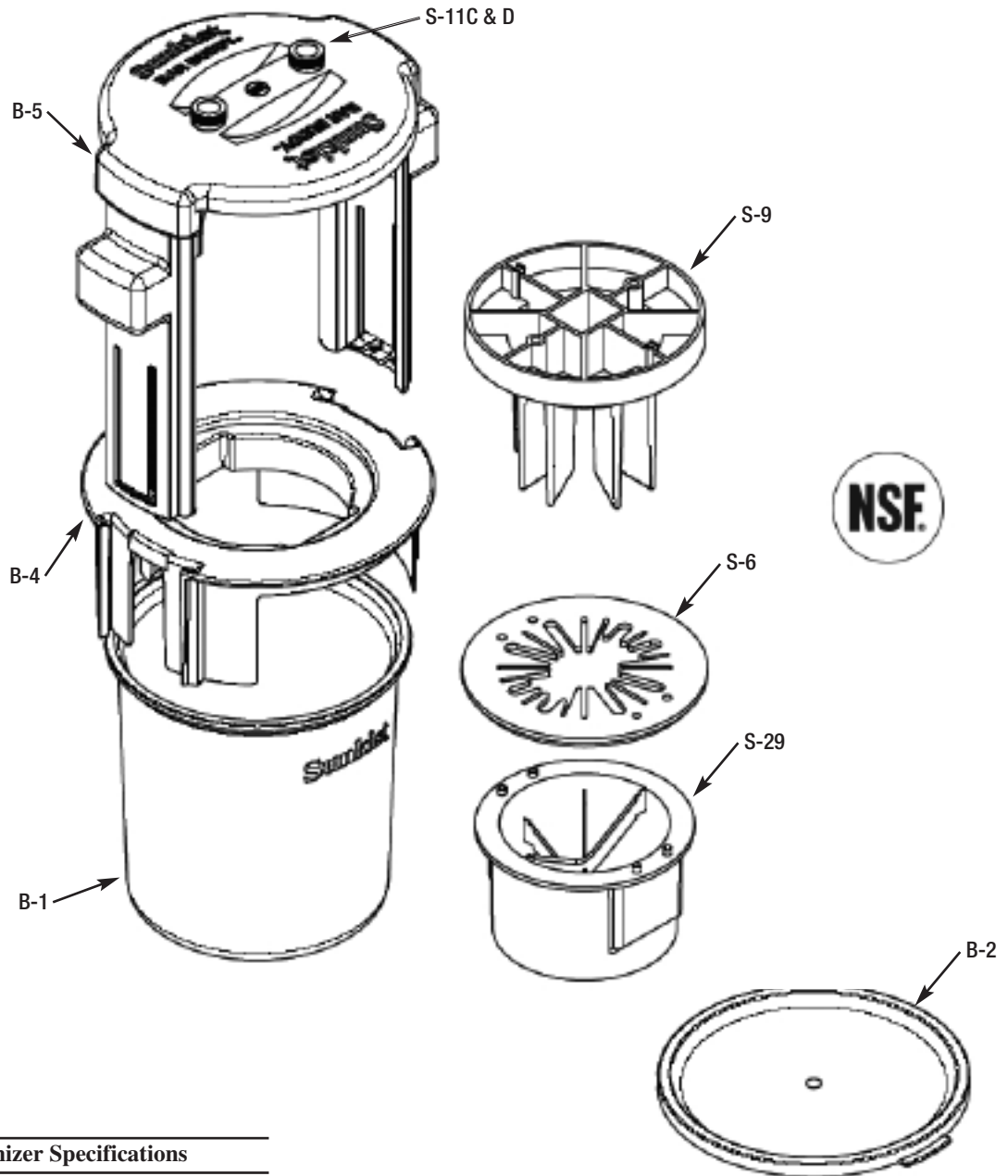

### Complete Bar Buddy™ Sectionizer Specifications

Safe...Listed by NSF International.

Overall Dimensions . . . . .9½" high, 9½" wide, 7" deep

Net Weight . . . . .4 pounds

Shipping Weight . . . . .5 pounds

Volume . . . . .0.47 cu.ft.

Carton Size . . . . .10" high, 10" wide, 8" deep

[foodservice.sunkist.com/equipment](http://foodservice.sunkist.com/equipment)

All prices quoted are FOB Fontana, CA and are subject to change without notice. These prices are also listed in AutoQuotes. The amount of any present or future tax shall be paid by the purchaser. There is **not** a minimum order fee for orders we drop ship to your customer, or for orders being sent to service centers for equipment waiting to be repaired. A service charge of \$10.00 will be added to all orders less than \$50.00 that are shipped to your location or one of your warehouses. CONTACT: Sunkist Foodservice Equipment Customer Service: (800) 383-7141 or (909) 355-4149. FAX orders to (909) 822-2125.

**Products must not be returned without a return authorization number.**